



HC1823849 [Main Bearing Set, Standard]

Instruction Guide

A revised front and intermediate crankshaft upper main bearing insert has been released with piston oil jet tube holes relocated to the center of the oil groove. This change provides increased load carrying capability of the bearing.

The top half of the main bearing insert is slotted to provide a flow of oil to the jet tubes and camshaft bushings as shown.

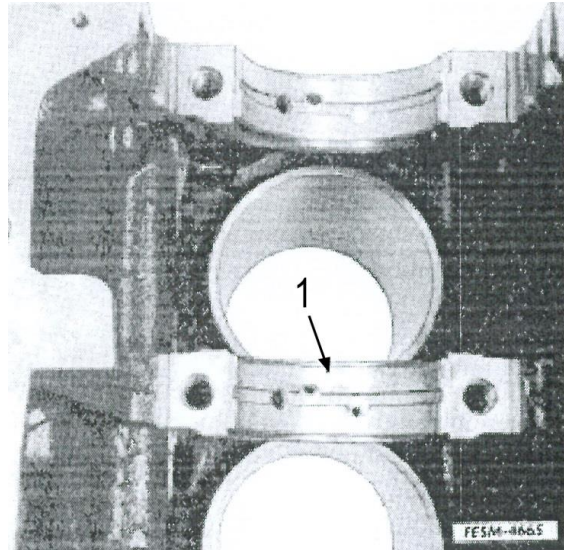

Main Bearing Insert – Old Style Shown w/Offset Piston Oil Jet Tube Holes

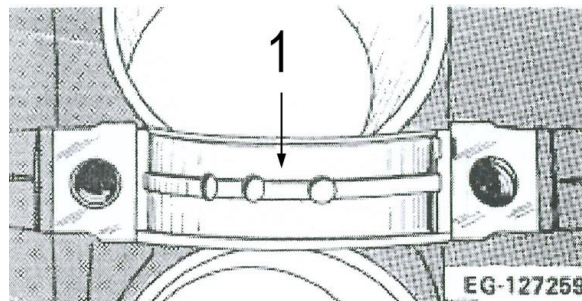

Main Bearing Insert – New Style w/ Piston Oil Jet Tube Holes in Line